



# KAYHAN INDUSTRIAL PRODUCTION GROUP

- Kayhan production & industry group founded in 1968, began its activity in the field of electricity and electronic industries in Iran. Gradually enhanced its products from branched and boosted antennas to different kinds of energy saving and florescent magnetic ballast and known as the largest manufacturer of magnetic Ballast, became the top supplier of power ministry of Iran. Then in the years between 2009 to 2014 expanded its activity to assembling variety of energy saving and Ultra energy saving lamps and from 2014 to 2017 has become to be known as one of the 3 poles of Iran's lamp & lighting industry.
- Today, with a very active presence in the countries such as UAE( Dubai), Azerbaijan( Baku), Iraq( Baghdad) and Afghanistan (Kabul), Kayhan Has continued the mass sales of its products and the raw material of the Ultra energy saving and also the vast programs of enhancing export, has made Kayhan production & industry group to pass the steps of success one after another by having a customer friendly attitudes, high quality and becoming universally known.
- Kayhan production & industry group employing 19000 square meter site in two regions of Guilan Province, 9000 square meter in Rasht Industrial city and 10000 square meter in Sefidrood Industrial city, has performed its productive and industrial activities.
- Products: Ultra Energy saving lamp, Energy saving lamps, Floodlights, Ultra energy saving Panels, Magnetic and Electronics Ballast and other products.



**KAYHAN**

INDUSTRIAL PRODUCTION GROUP

Ultra energy saving LED

25000hrs **2years** guarantee

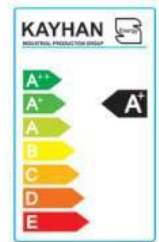
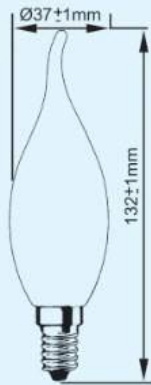

**TAILED CANDLE ( CLEAR & FROSTED )**

TYPE	Watt(w)	Voltage(v)	I(ma)	LUMEN(lm)	LED	BASE	Size(RxH)(mm)	EEL	Beam angle
C37 SMD	6	220-240	53	550	2835	E14	Ø37x132	A <sup>+</sup>	200°
C37 COB	6	220-240	53	550	2835	E14	Ø37x132	A <sup>+</sup>	200°
C37 SMD	3	220-240	22	230	2835	E14	Ø37x132	A <sup>+</sup>	200°

**KAYHAN**

INDUSTRIAL PRODUCTION GROUP

Ultra energy saving LED

25000hrs **2years** guarantee

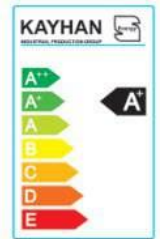
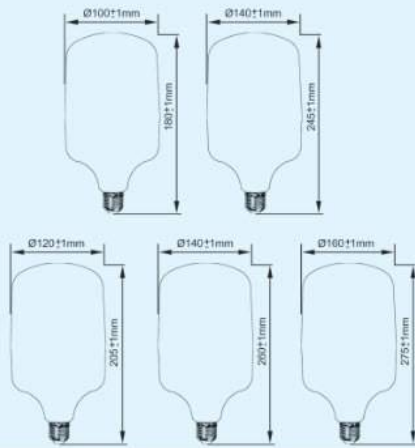

**High Power T series**

TYPE	Watt(w)	Voltage(v)	I(ma)	LUMEN(lm)	LED	BASE	Size(RxH)(mm)	EEL	Beam angle
T100 SMD	32	220-240	130	3000	2835	E27	Ø100x180	A <sup>+</sup>	150°
T140 SMD	40	220-240	320	3800	2835	E27	Ø140x245	A <sup>+</sup>	150°
T120 SMD	42	220-240	170	4200	2835	E27	Ø120x205	A <sup>+</sup>	150°
T140 SMD	52	220-240	220	5200	2835	E27	Ø140x260	A <sup>+</sup>	150°
T160 SMD	65	220-240	510	6000	2835	E27	Ø160x275	A <sup>+</sup>	150°

**KAYHAN**  
INDUSTRIAL PRODUCTION GROUP  
Ultra energy saving LED  
25000hrs **2years** guarantee

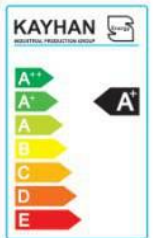
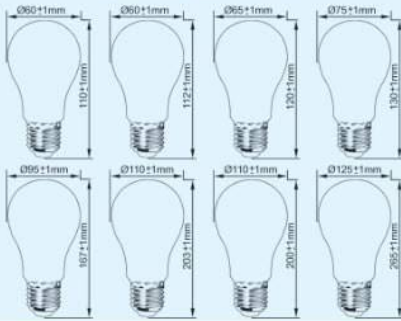

**Bulb A series**

TYPE	Watt(w)	Voltage(v)	I(ma)	LUMEN(lm)	LED	BASE	Size(RxH)(mm)	EEL	Beam angle
A60 SMD	9	220-240	70	800	2835	E27	Ø60 x 110	A <sup>+</sup>	220°
A60 SMD	10	220-240	60	850	2835	E27	Ø60 x 112	A <sup>+</sup>	220°
A60 SMD	11	220-240	70	1050	2835	E27	Ø60 x 112	A <sup>+</sup>	220°
A60 SMD	12	220-240	68	1050	2835	E27	Ø60 x 112	A <sup>+</sup>	220°
A65 SMD	15	220-240	105	1470	2835	E27	Ø65 x 120	A <sup>+</sup>	220°
A75 SMD	18	220-240	155	1700	2835	E27	Ø75 x 130	A <sup>+</sup>	220°
A95 SMD	20	220-240	165	2000	2835	E27	Ø95 x 167	A <sup>+</sup>	220°
A110 SMD	30	220-240	225	3000	2835	E27	Ø110 x 203	A <sup>+</sup>	220°
A110 SMD	40	220-240	330	4000	2835	E27	Ø110 x 200	A <sup>+</sup>	220°
A125 SMD	55	220-240	430	4900	2835	E27	Ø125 x 265	A <sup>+</sup>	220°

**KAYHAN**

INDUSTRIAL PRODUCTION GROUP

Ultra energy saving LED

25000hrs **2years** guarantee

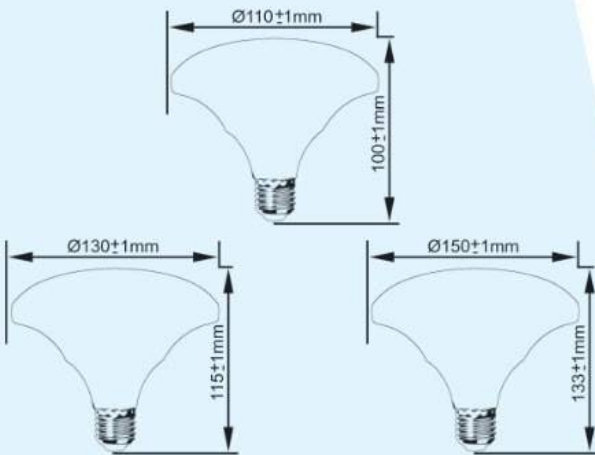

**High Power UFO series**

TYPE	Watt(w)	Voltage(v)	I(ma)	LUMEN(lm)	LED	BASE	Size(RxH)(mm)	EEL	Beam angle
S110 SMD	28	220-240	210	2400	2835	E27	Ø110x100	A+	150°
S130 SMD	38	220-240	280	3400	2835	E27	Ø130x115	A+	150°
S150 SMD	48	220-240	360	4500	2835	E27	Ø150x133	A+	150°

**KAYHAN**

INDUSTRIAL PRODUCTION GROUP

Ultra energy saving LED

25000hrs **2years** guarantee

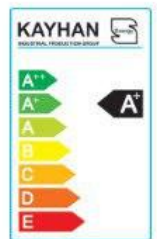
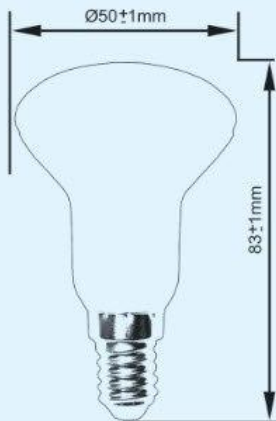

**R 50**

TYPE	Watt(w)	Voltage(v)	I(ma)	LUMEN(lm)	LED	BASE	Size(R x H)(mm)	EEL	Beam angle
R50 SMD	6	220-240	40	500	2835	E14	Ø50x83	A <sup>+</sup>	120°

**KAYHAN**

INDUSTRIAL PRODUCTION GROUP

Ultra energy saving LED

25000hrs **2years** guarantee

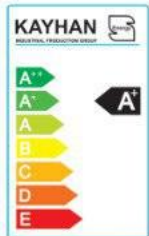

HIGH BAY								
TYPE	Watt(w)	Voltage(v)	I(ma)	LUMEN(lm)	LED	BASE	EEL	Beam angle
T100 SMD	30	220-240	230	3000	2835	E27	A <sup>+</sup>	> 120°
T140 SMD	40	220-240	300	4000	2835	E27	A <sup>+</sup>	> 120°
T120 SMD	50	220-240	325	5000	2835	E27	A <sup>+</sup>	> 120°



**KAYHAN**

INDUSTRIAL PRODUCTION GROUP

Ultra energy saving LED

25000hrs **2years** guarantee

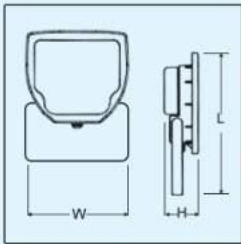

12w 30w 60w

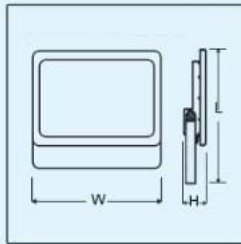

100w

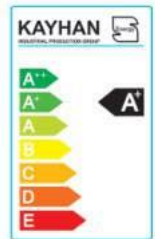

**FLOODLIGHT (IP65)**

TYPE	Watt(w)	Voltage(v)	I(ma)	LUMEN(lm)	LED	Size(LxWxH)(mm)	EEL	DRIVER INFO.
FL11-012C SMD	12	220-240	40	850	2835	142 x118x51	A <sup>+</sup>	PF>0.9
FL11-030C SMD	30	220-240	130	2600	2835	166x165x64	A <sup>+</sup>	PF>0.9
FL11-060C SMD	60	220-240	210	4250	2835	230x213x78	A <sup>+</sup>	PF>0.9
FL27-100C SMD	100	220-240	360	7500	2835	290x230x32	A <sup>+</sup>	PF>0.9

**KAYHAN**

INDUSTRIAL PRODUCTION GROUP

Ultra energy saving LED

25000hrs **2years** guarantee

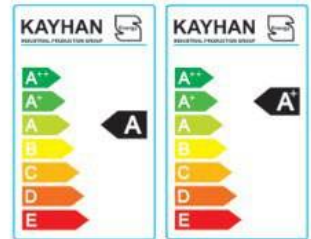
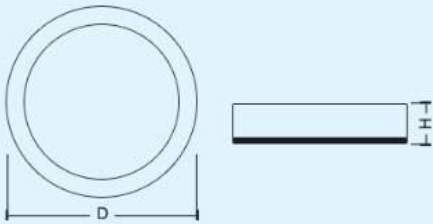

**GLASS PANEL LIGHT**

TYPE	Watt(w)	Voltage(v)	I(ma)	LUMEN(lm)	LED	Size(DxH)(mm)	CUT SIZE(mm)	EEL	DRIVER INFO.
PL LED SMD	7	220-240	60	360	2835	Ø98x38	Ø76	A <sup>+</sup>	PF>0.5
PL LED SMD	12	220-240	125	720	2835	Ø160x38	Ø128	A	PF>0.5
PL LED SMD	18	220-240	170	1080	2835	Ø200x38	Ø165	A	PF>0.5
PL LED SMD	24	220-240	238	1200	2835	Ø238x38	Ø205	A	PF>0.5

**KAYHAN**

INDUSTRIAL PRODUCTION GROUP

Ultra energy saving LED

25000hrs **2years** guarantee

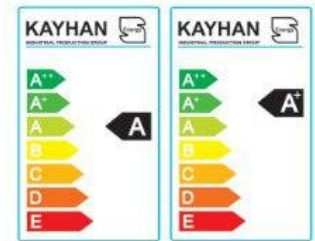
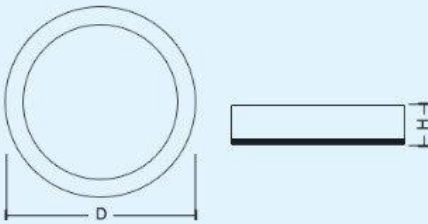

**SLIM PANEL LIGHT**

TYPE	Watt(w)	Voltage(v)	I(ma)	LUMEN(lm)	LED	Size(D x H)(mm)	CUT SIZE (mm)	EEI	DRIVER INFO.
PL LED SMD	7	220-240	60	360	2835	Ø112 x 10	Ø105	A*	PF>0.5
PL LED SMD	18	220-240	160	1200	2835	Ø225 x 10	Ø200	A	PF>0.5

**KAYHAN**

INDUSTRIAL PRODUCTION GROUP

Ultra energy saving LED

25000hrs **2years** guarantee

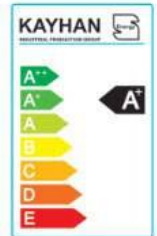
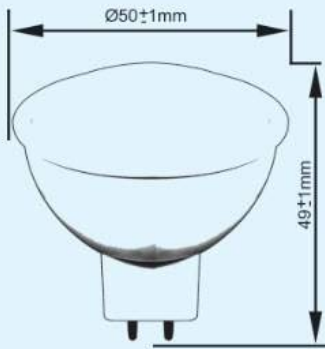

**HALOGEN SMD&COB**

TYPE	Watt(w)	Voltage(v)	I(ma)	LUMEN(lm)	LED	BASE	Size(RxH)(mm)	EEL	Beam angle
MR16 SMD	6W	175-230	50	520	2835	GU5.3	Ø50x49	A*	100°
MR16 COB	6W	175-230	50	520	2835	GU5.3	Ø50x49	A*	35°

**KAYHAN**

INDUSTRIAL PRODUCTION GROUP

Ultra energy saving LED

30000hrs **2years** guarantee

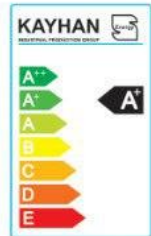
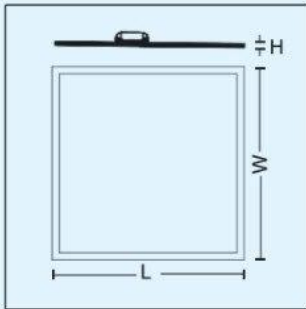

PANEL 60x60								
TYPE	Watt(w)	Voltage(v)	I(ma)	LUMEN(lm)	LED	Size(LxWxH)(mm)	EEL	DRIVER INFO.
PL512-2240 SMD	40	220-240	190	2800	2835	595x595x10.5	A*	PF>0.9
PL512-2250 SMD	50	220-240	200	3600	2835	595x595x10.5	A*	PF>0.9
PL512-2260 SMD	60	220-240	200	5000	2835	595x595x10.0	A*	PF>0.9

**KAYHAN**

INDUSTRIAL PRODUCTION GROUP

energy saving CFL LIGHTS

8000hrs **1years** guarantee



HALF SPIRAL



FULL SPIRAL



LOTUS

CFL LIGHTS						
TYPE	Watt(w)	BASE	Voltage(v)	I(ma)	LUMEN(lm)	F(hz)
CFL FULL-SPIRAL	11	E14	220-240	75	500	50-60
CFL FULL-SPIRAL	18	E27	220-240	120	1000	50-60
CFL HALF SPIRAL	26	E27	220-240	174	1400	50-60
CFL FULL-SPIRAL	26	E27	220-240	174	1400	50-60
CFL FULL-SPIRAL	35	E27	220-240	270	2250	50-60
CFL HALF SPIRAL	40	E27	220-240	300	2200	50-60
CFL FULL-SPIRAL	55	E27	220-240	400	3000	50-60
CFL FULL-SPIRAL	65	E27	220-240	480	3300	50-60
CFL HALF SPIRAL	75	E27	220-240	500	4500	50-60
CFL Lotus	85	E27	220-240	560	5500	50-60
CFL Lotus	105	E27	220-240	750	6500	50-60
CFL Lotus	125	E27	220-240	785	7500	50-60
CFL Lotus	200	E40	220-240	980	9500	50-60

**KAYHAN**

INDUSTRIAL PRODUCTION GROUP

Ultra energy saving LED

25000hrs **2years** guarantee

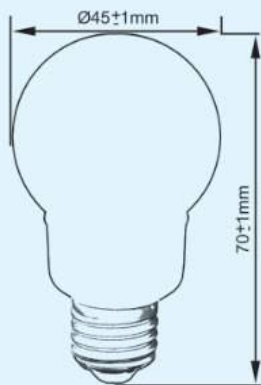

**LED BULB 1W RGB**

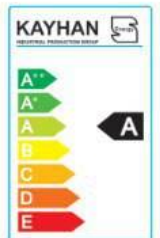

**1W BULB RGB**

TYPE	Watt(w)	Voltage(v)	I(ma)	LUMEN(lm)	LED	BASE	Size(RxH)(mm)	EEL	Beam angle
1W A TYPE SMD	1W	220-240	56	15	2835	E27	Ø45x70	A	>120°



Accredited by NTA



Dutch Council for Certification

[www.kayhan-ip-group.ir](http://www.kayhan-ip-group.ir)

Email: [kayhan.product1368@gmail.com](mailto:kayhan.product1368@gmail.com)

Address: Sefidrood Industrial Estate, Rasht, Guilan, Iran

Phone: +98 13 32000471

TelFax: +98 13 32000475